

표준 삼상 B5 - FF130 (71M-V01)

CODE No

Model No	Out Put (kW)				Volt	Hz	IP	Ins cl.	Time	Bearing		Type
	2P	4P	6P	8P						DE	ODE	
		0.4					54	B	S1	6203ZZ	6202ZZ	TEFC

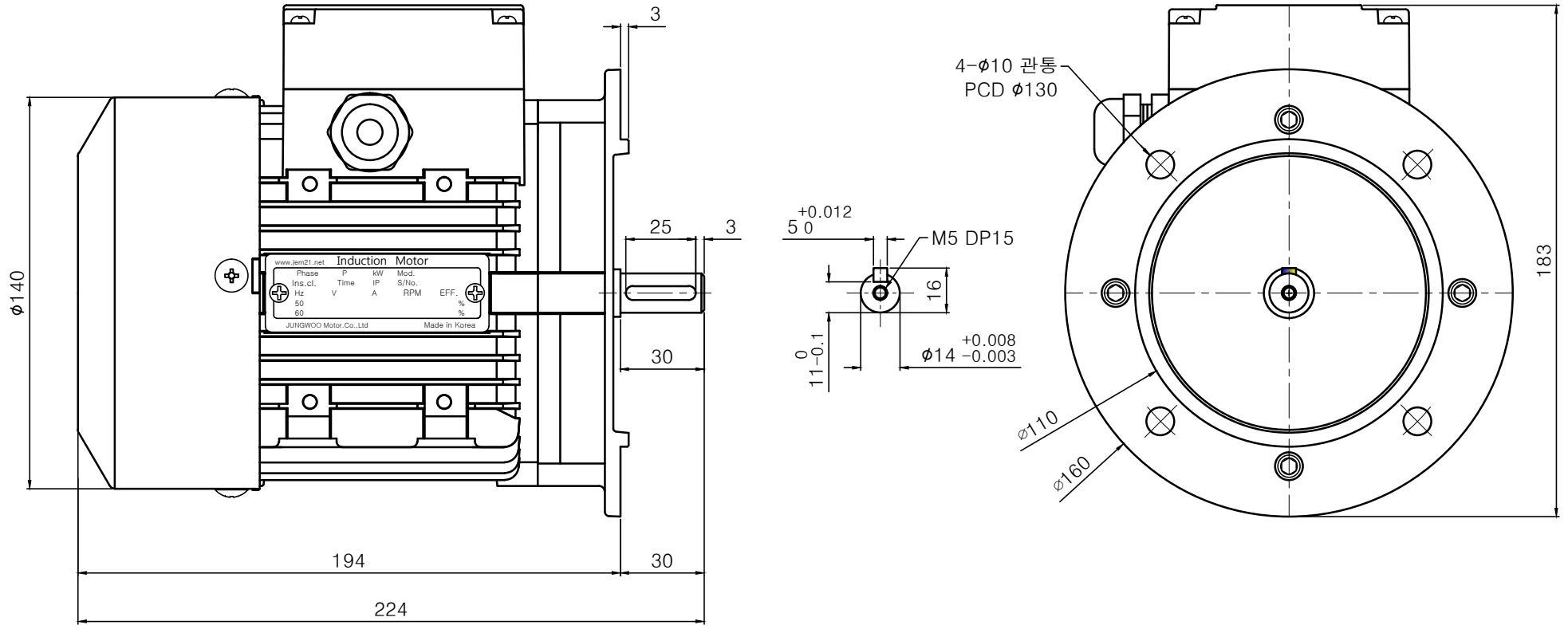

STYLE	3rd Angle	TITLE	Induction Motor Out Line
UNIT	MM	 정우전기 (주)	
SCALE	1 : 1		
DATE	2023.06.27		
DSND BY	KOH.Y.K		