

REDUCER SPEC	
MODEL	B123
SERVICE FACTOR	1.2
RATIO	30.79
OUTPUT [rpm]	56.8
OUTPUT TORQUE [Nm]	2269
WEIGHT [kg]	87.7

MOTOR SPEC	
MODEL	TE-F 호성 IE3
POWER [kW]	15
POLE, PHASE	4P, 3PHASE
INPUT [rpm]	1750
BRAKE	NO
WEIGHT [kg]	171

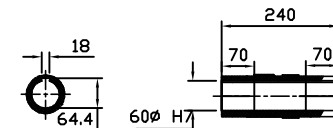
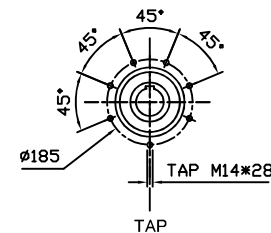
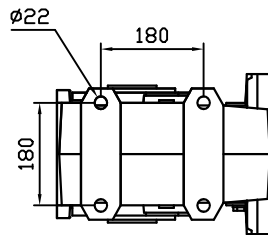
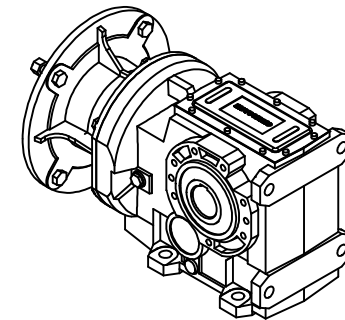
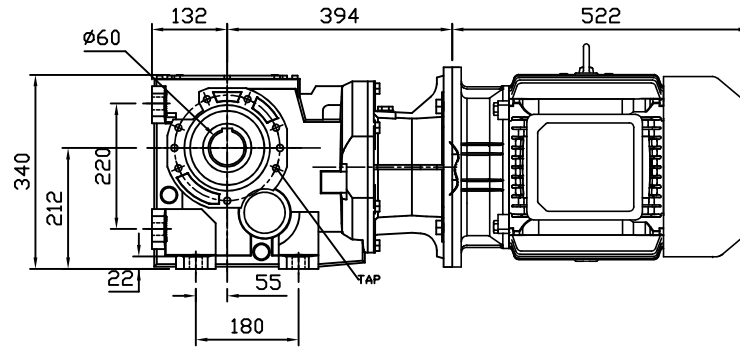
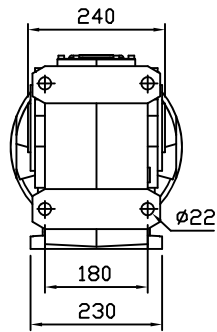

OUTPUT HOLLOW SHAFT

(주)한국체인모터

Tel. 032-815-8888 Fax. 815-8020
www.hcmfa.com

PROJECT		MOTOVARIO					
DRAWN	SED Y.S	DATE		REV	A	SCALE	1:1
CHECKED	KIM J.S	DATE		UNIT	MM	PAGE	-
APPROVED	LEE J.Y	DATE					