

REDUCER SPEC	
MODEL	BA72 P
SERVICE FACTOR	
RATIO	
OUTPUT [rpm]	
OUTPUT TORQUE [Nm]	
WEIGHT [kg]	5.8

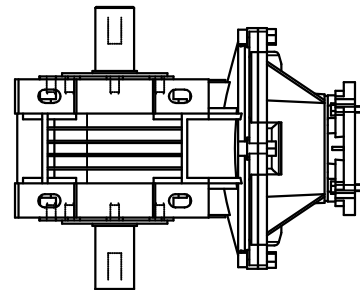
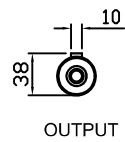
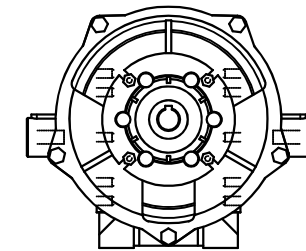
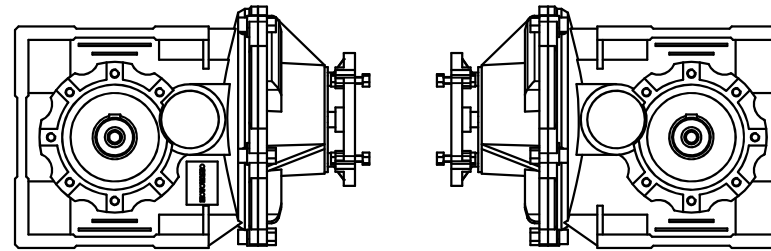
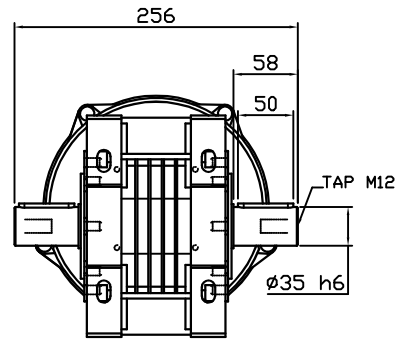
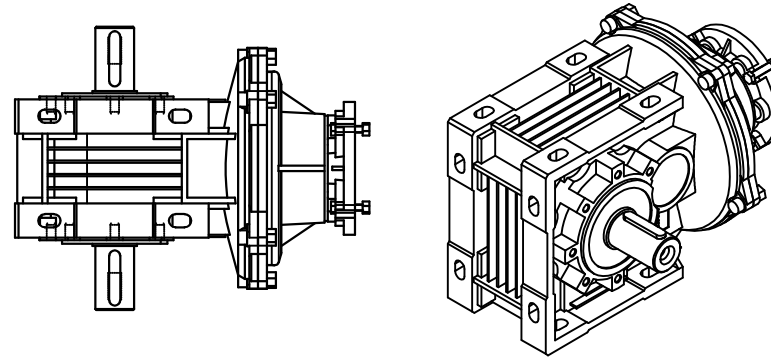

PROJECT		MOTOVARIO						
DRAWN	SEO Y.S	DATE		REV	A	SCALE	1:1	
CHECKED	KIM J.S	DATE		UNIT	MM	PAGE	-	
APPROVED	LEE J.Y	DATE		